

Dressing for the Occasion

Tucked away in this word-search puzzle are 20 items (listed at the bottom of the page) that English and Western riders need to outfit themselves from head to toe. See if you can find and circle them all. It may be a little tricky, as the words are printed forward, backward, up, down, and diagonally.

S	H	I	R	T	S	T	S	T	S	I	S	B	T
J	A	C	K	E	T	B	L	M	R	E	I	E	M
Y	E	T	V	S	S	V	O	E	E	I	T	M	L
P	O	O	A	B	Q	G	E	W	B	T	T	L	L
T	L	J	O	A	F	Y	C	Z	C	L	S	E	H
G	W	O	A	R	H	F	V	H	N	E	F	F	R
E	T	D	Y	E	R	H	E	L	A	F	F	R	S
S	I	H	S	B	S	E	L	P	E	R	R	A	S
W	U	P	G	T	R	J	K	S	R	A	C	T	O
S	R	U	P	S	T	H	K	O	D	C	C	O	C
D	D	R	O	L	O	B	D	Z	H	S	S	C	C
G	Q	S	N	O	S	T	E	T	S	S	C	C	K

- | | | | |
|-----------------|---------------|-----------------|----------------|
| BELT | CHAPS | JACKET | SPURS |
| BOLO | CHOKER | JEANS | STETSON |
| BOOTS | DERBY | JODHPURS | STOCK |
| BOWLER | GLOVES | SCARF | TIE |
| BREECHES | HELMET | SHIRT | VEST |

How Many Horses?

The new riding student arrived early for her lesson. While she waited for her instructor to show up, she decided to count the herd, but the horses kept moving around and she had trouble getting an accurate count. See if you can help her out by circling the word HORSE as many times as it appears in the paddock below. You'll need a sharp eye because it may be spelled forward, backward, up, down, or diagonally! *Hint: there are 16 horses.*

H S H O R R S H E H H E
O O E S R R O H O R O S
R H R R R E H O R R R
S E O S R E F R E F E H
S H S O S E S R R O H
R H R R R E R S O R F
O O E O S O S O R
H S H H H E H S H

Cooking Up Horse Names

Besides cooking, the Canterring Chef's favorite pastime is riding horses. So for his birthday, his family decided to give him a half-dozen horses, each one a different color. Delighted, the cook decided to name the horses after some of his favorite foods. See if you can make the right matches.



- | | |
|------------------------|-----------------------|
| Strawberry Roan | Butterscotch |
| Paint | Shortcake |
| Brown | Powdered Sugar |
| Palomino | Marble Cake |
| Black | Licorice |
| Appaloosa | Cocoa |

Equine Stall of Fame

Can you fill in the correct letter to match up the famous horses and ponies on the left with their human, television character, or celestial companions?

Silver _____

A Wild Bill Hickock

Brown Beauty _____

B John Wayne

Mr. Ed _____

C Gummy

The Pie _____

D Zorro

Duke _____

E Annie Oakley

Trigger _____

F Paul Revere

Buckshot _____

G Velvet Brown

Poky _____

H The Lone Ranger

Target _____

I Dale Evans

Pegasus _____

J Tonto

Phantom _____

K Perseus

Buttermilk _____

L Wilbur Post

Scout _____

M Roy Rogers

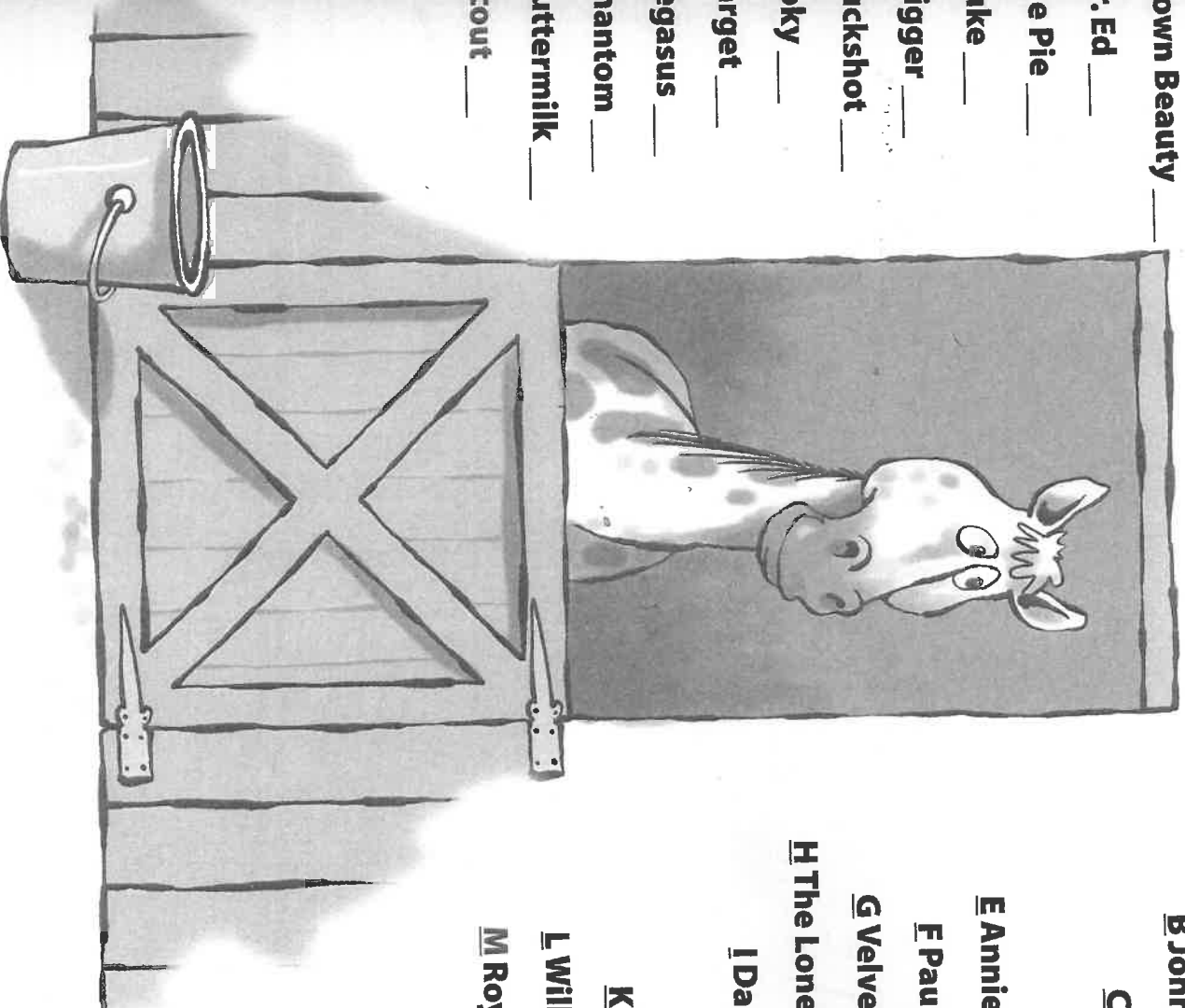

Gymkhana Games

During gymkhana competitions, not only do Western riders have to ride as fast as they can, but they need to remember the course for each game as well! See if you can draw the correct riding patterns for the events pictured here.

Keyhole Race

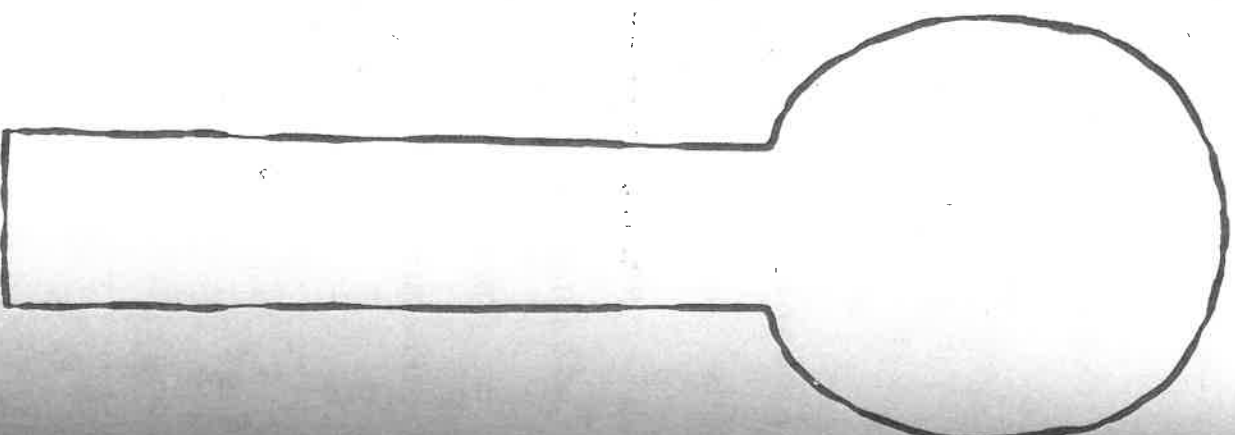

Barrel Race

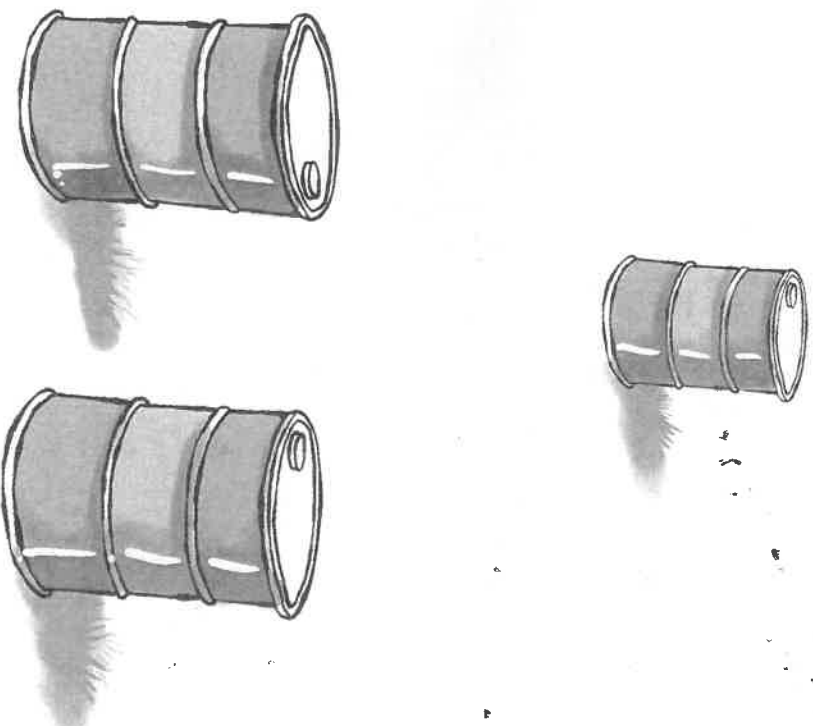

Start/Finish Line

Start/Finish Line

Pole Bending

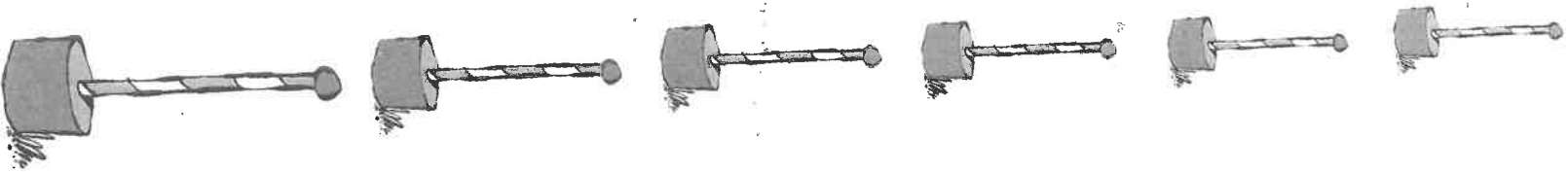

Start/Finish Line

Flag Race

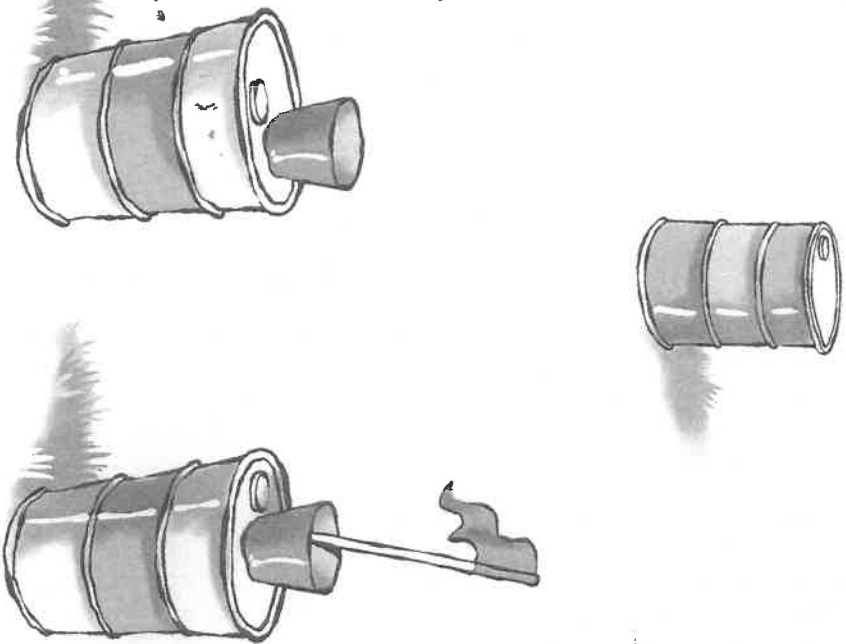

Start/Finish Line

Making Faces

Many horses have distinct white patches on their faces. Just for fun, try outlining the facial markings described under the horse heads pictured here, and then see how your drawings compare to the ones shown on the answer page.

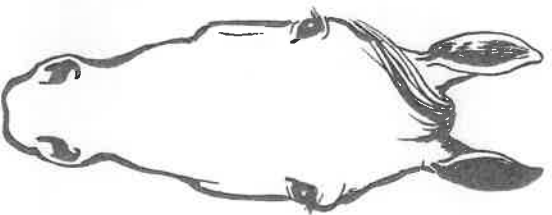

Draw a Star
(a roundish blotch on the forehead)

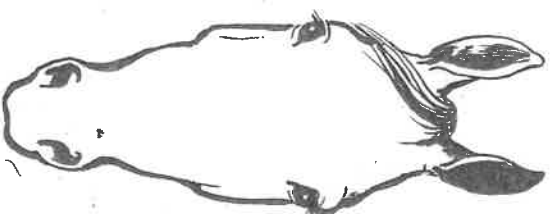

Draw a Strip
(a narrow strip that runs down the center of the nose)

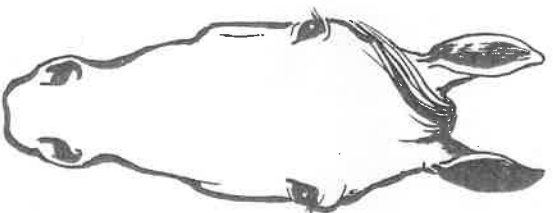

Draw a Blaze
(a broad stripe that typically runs the length of the face)

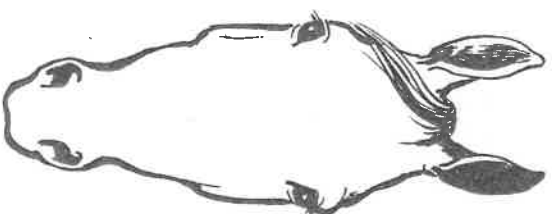

Draw a Snip
(a roundish blotch between the nostrils)

Putting On Socks

Horses can have a variety of distinguishable leg markings, too. Try your hand at drawing on the patterns identified below. Put one sock on each leg.

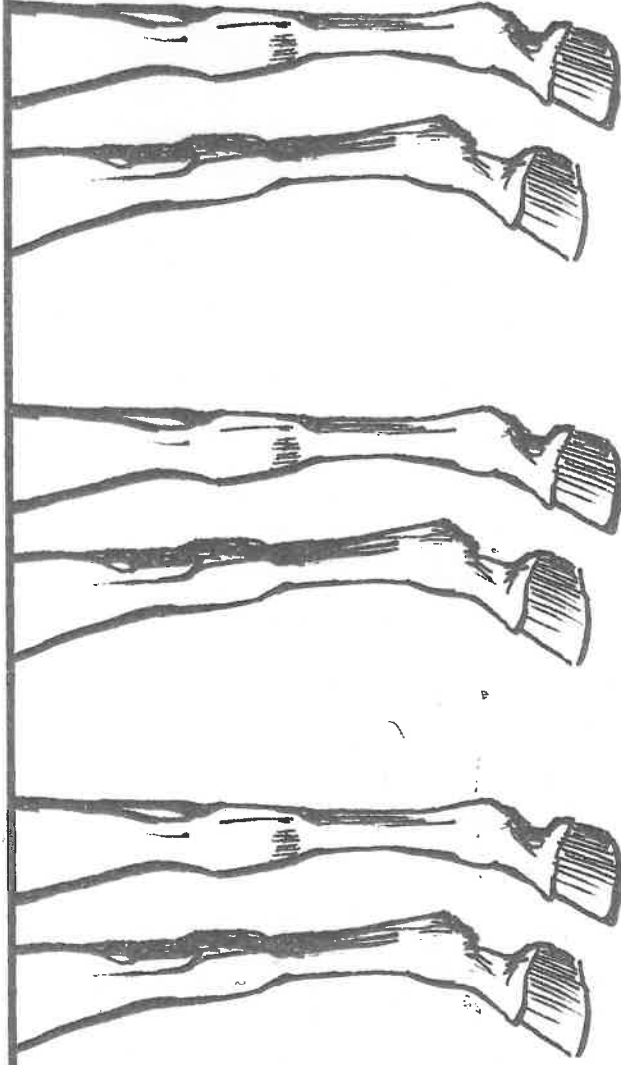

Draw a Coronet Marking

(a thin white band just above the hoof)

Draw a Pastern Marking

(a thick white band that extends from the hoof to just below the fetlock)

Draw a Sock

(a white marking that extends from the hoof to a third of the way up the cannon bone)

Draw a Half-stocking

(white coloring that extends from the hoof to half way up the cannon bone)

Draw a Full Stocking

(white coloring that extends from the hoof to just below the knee)

Draw a Heel Marking

(a blotch of white just above the back of the hoof)